

# Non-Concussive Fittings (Self Closing)

Dimensions in millimeters

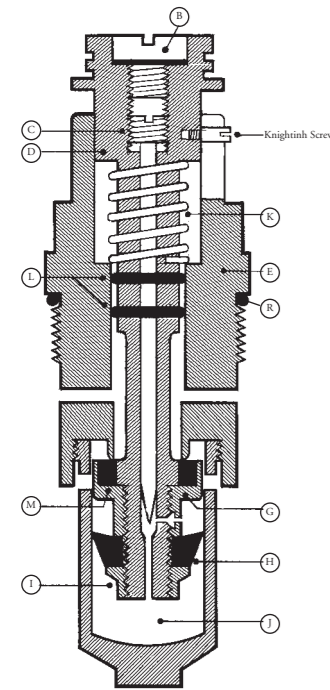

## Adjustable Headworks



- B Sealing Screws
- C Adjustable Needle
- D Main Spindle
- E Cover
- R 'O' Ring Seal
- G Seating
- H Cup Washer (Rubber)
- I Washer Lock Nut
- J Chamber
- K Spring
- L 2 'O' Rings
- M Seating Washer

The Barwil Non-concussive valve is adjustable under varying pressures whilst it is fixed and in use. Remove the easy-clean shield (A) which is grub screwed to the main body. This will expose the sealing screw (B) which, when removed, allows access to the adjusting needle (C). This is slotted to take a small screwdriver and by turning the spindle down for high pressure and up for low pressure, the valve can be regulated perfectly. This mechanism is used in non-concussive valves numbered: 2722, 2724, 2726, 2727, 2728, 2729, 2750, 2754, 2780.

NC2724 Bibcock

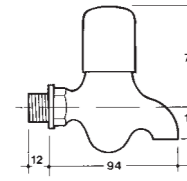

NC2720 Pillar Valve

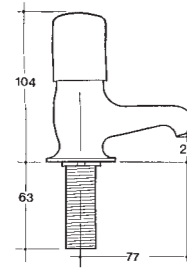

## Horizontal Bibcocks

NC2726 Bibcock

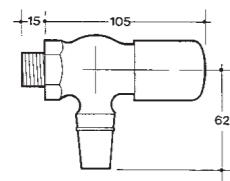

NC2726 Bibcock

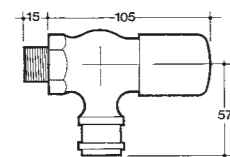

## Adjustable Stopcocks

NC2727 Foot Operated Stopcock

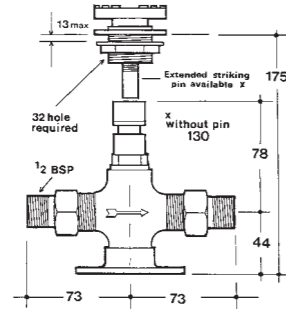

NC2728 Stopcock

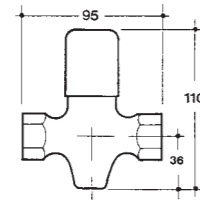

NC2729 Stopcock

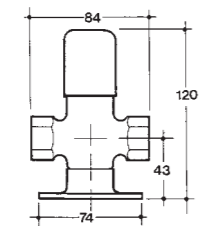

## Adjustable Valves

NC2750 Pillar Valve

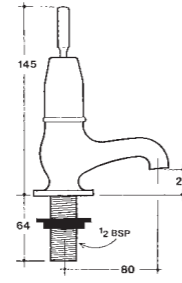

NC2750B Pillar Valve

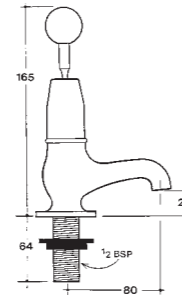

NC2754 Bibcock

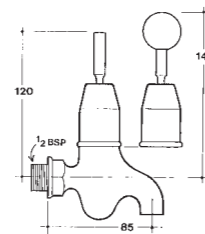

## Current WRC Listings

Model No.	Certificate No.	I.R.N. No.	Water Byelaw
2720	0607051	109	16 & 18
2722	0607053	109	16 & 18
2724	0607052	109	16 & 18
2726	0607052	109	16 & 18
2727	0607054	109	16 & 18
2728	0607054	109	16 & 18
2729	0607054	109	16 & 18
2750	0607051	001	N/A
2780	0607053	001 & 109	16 & 18
HEC/HFC 1010	0202028*	000	N/A
HEC/HFC 2010	0202028*	000	N/A
HEC/HFC 2015	0202028*	000	N/A

\*new listing applied for.



By Appointment to  
Her Majesty Queen Elizabeth II  
Manufacturer of Kitchen & Bathroom Taps & Mixers  
Barber Wilsons & Co. Ltd.

# BARBER WILSONS & CO LTD



Barber Wilsons & Co Ltd  
Crawley Road Westbury Avenue  
Wood Green London N22 6AH

Tel +44 (0)208 888 3461  
Fax +44 (0)208 888 2041  
Email sales@barwil.co.uk

www.barwil.co.uk  
www.barberwilsons.com



NON - CONCUSSIVE  
&  
HOSPITAL WATER FITTINGS



Barber Wilsons & Co Limited is constantly seeking ways to improve the specifications, design and production of its products and alterations take place continually. Whilst every effort is made to produce up to date literature this brochure should not be regarded as an infallible guide to current specifications. Refer to our price list for our terms and conditions of sale. E & OE.